

# STNDRD.®

## 3-LEGGED BAMBOO END TABLE

### WARNING:

Choking hazard. Please keep all parts and packaging away from small children.

### Need help? We're here for you.

Email us at [help@stndrdfurniture.co](mailto:help@stndrdfurniture.co)

A copy of these assembly instructions can be found at [stndrdfurniture.co/endtable](http://stndrdfurniture.co/endtable)

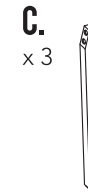
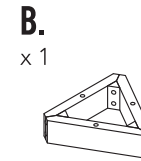
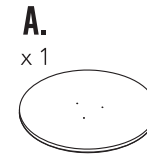
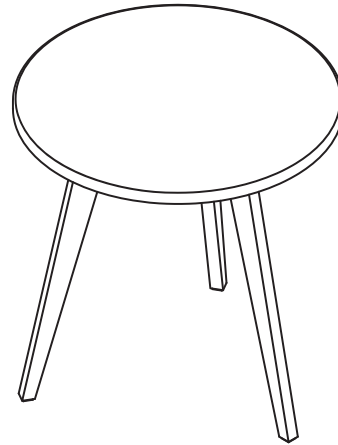

⊕ PLEASE NOTE:  
You will also need a  
Phillips screwdriver  
(not included)

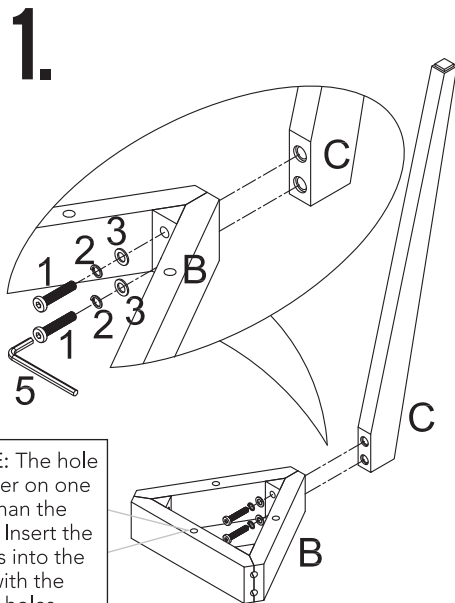
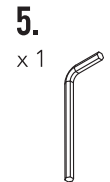
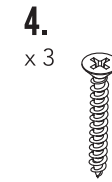
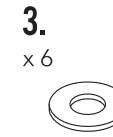
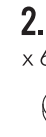

NOTE: The hole is larger on one side than the other. Insert the screws into the side with the larger holes.

